

ITEM	PART NO.	DESCRIPTION	QTY.
1	151703-10	SPROCKET SPACER .625	1
2	357337-28	SHCS 3/8-24 x 1.75	6
3	352503-06	3/8 AN WASHER	6

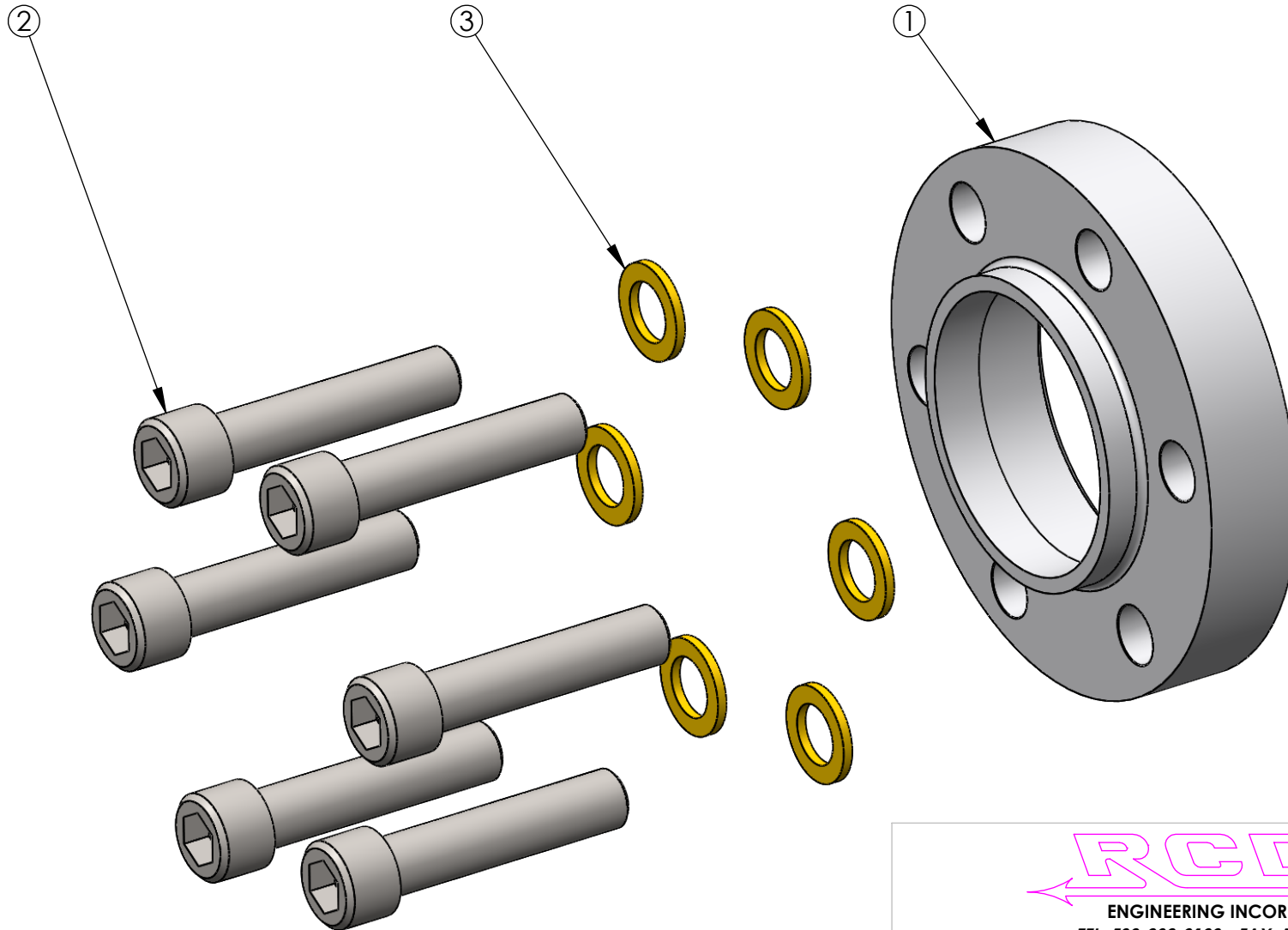

ENGINEERING INCORPORATED
 TEL: 530-292-3133 - FAX: 530-292-3738

SPROCKET SPACER .625 W-BOLTS